

# Tec 7 Vaporizer

## User's Reference Manual



## User Responsibility

This Product will perform in conformity with the description thereof contained in this User's Reference manual and accompanying labels and/or inserts, when assembled, operated, maintained, and repaired in accordance with the instructions provided. This Product must be checked periodically. A defective Product should not be used. Parts that are broken, missing, plainly worn, distorted, or contaminated should be replaced immediately. Should repair or replacement become necessary, Datex-Ohmeda recommends that a telephonic or written request for service advice be made to the nearest Datex-Ohmeda Customer Service Center. This Product or any of its parts should not be repaired other than in accordance with written instructions provided by Datex-Ohmeda and by Datex-Ohmeda trained personnel. The Product must not be altered without the prior written approval of Datex-Ohmeda. The user of this Product shall have the sole responsibility for any malfunction which results from improper use, faulty maintenance, improper repair, damage, or alteration by anyone other than Datex-Ohmeda.

### CAUTION

U.S. Federal law restricts this device to sale by or on the order of a licensed medical practitioner. Outside the U.S.A, check local laws for any restriction that may apply.

Datex-Ohmeda products have unit serial numbers with coded logic which indicates a product group code. The year of manufacture and a sequential unit number for identification.

AAA A 12345



This alpha character indicates the year of product manufacture and when the serial number was assigned; "C" = 1999, "D" = 2000, "E" = 2001, etc. "I" and "O" are not used.

# Table of Contents

## 1 Introduction

Precautions .....	1-1
Symbols .....	1-2

## 2 Description

What is a Tec 7 Vaporizer? .....	2-1
Components .....	2-3
Control dial .....	2-3
Safety interlocks .....	2-3
Vaporizer identification label .....	2-3

## 3 Setup and Mounting Procedure

Vaporizer mounting procedure .....	3-1
Mounting the vaporizer .....	3-2
Checking the vaporizer for correct mounting .....	3-4
Removing the vaporizer from a manifold .....	3-4

## 4 Operating Instructions

Setting the dial .....	4-1
Filling and draining the vaporizer .....	4-3
Filling procedure with funnel filler .....	4-5
Draining procedure with funnel filler .....	4-6
Filling procedure with Easy-Fil™ .....	4-7
Draining procedure with Easy-Fil .....	4-8
Filling procedure with Quik-Fil™ .....	4-9
Draining procedure with Quik-Fil .....	4-10

## 5 Maintenance

User maintenance .....	5-1
Maintenance intervals .....	5-1
Cleaning .....	5-2
External cleaning .....	5-2
Internal contamination .....	5-2
Output concentration check .....	5-2
Checking the calibration .....	5-3
Analytical techniques .....	5-4
Service Policy .....	5-5

## 6 Principle of Operation

Interlock mechanism .....	6-1
Delivery of gas/agent vapor .....	6-1
Overview .....	6-1
Bypass circuit .....	6-2
Vaporizing chamber circuit .....	6-2

## 7 Specifications

Calibration .....	7-1
Performance .....	7-2
Weight and dimensions .....	7-2
Flow characteristics .....	7-3
Effects of variables .....	7-8
Anesthetic agent consumption .....	7-8
Barometric pressure .....	7-8
Ambient temperature .....	7-9
Back pressure .....	7-9
Carrier gas composition .....	7-10
Time out of service .....	7-10
Effects of variables .....	7-10

## Warranty

# 1 Introduction

## Precautions

### **WARNING**

Do not fill the vaporizer with any agent other than the agent specified on the front label. The vaporizer is designed for that agent only. If any substance other than that specified is used, patient injury could occur.

United States (U.S.) Federal law restricts this device to sale by or on the order of a licensed medical practitioner. Outside the U.S., check local laws for any restrictions that may apply.

Do not attempt to use a vaporizer that has been dropped. A dropped vaporizer **MUST** be sent to the nearest Datex-Ohmeda Field Operations Unit for servicing.

Do not use malfunctioning equipment. Make all necessary repairs or have the equipment serviced by an authorized Datex-Ohmeda service center. After repair, test the equipment to ensure that it is functioning properly in accordance with the manufacturer's published specifications.

**Important**

European Standard EN 740 - *Anesthetic Workstations and Their Modules* requires that an appropriate gas monitor is used to monitor the concentration of anesthetic agent vapor in the inspiratory gas when the vaporizer is in operation in order to provide protection against hazardous output in the event of a device malfunction.

Datex-Ohmeda strongly recommends the use of anesthesia gas monitoring with this equipment. Refer to local standards for mandatory monitoring.

Requests for servicing facilities, advice or assistance must be addressed to a local Datex-Ohmeda office.

Additional copies of this manual, can be requested from a local Datex-Ohmeda Field Operations Unit or a Datex-Ohmeda Authorized Distributor.

Datex-Ohmeda strongly recommends that you keep all relevant documentation, including this manual and accompanying labels, immediately available to all users.

**Symbols**

Warnings and Cautions tell you about conditions that can occur if you do not follow all instructions in this manual.

 **WARNING** Warnings tell about a condition that can cause injury to the operator or the patient.

 **CAUTION** Cautions tell about a condition that can cause damage to the equipment. Read and follow all warnings and cautions.



Caution: federal law prohibits dispensing without prescription.

OFF symbol/OFF setting

SEV Sevoflurane

% v/v Percentage of anesthetic vapor per total volume.

ISO Isoflurane

 Lock

ENF Enflurane

 Unlock

HAL Halothane

 Caution or Warning

 Maximum Agent Level

 Direction of flow

 Minimum Agent Level

 Stock number



Systems with this mark agree with the European Council Directive (93/42/EEC) for Medical Devices when they are used as specified in their User's Reference manuals. The xxx is the certification number of the Notified Body used by Datex-Ohmeda's Quality Systems.

 Serial number

## 2 Description

### What is a Tec 7 Vaporizer?

The Tec 7 Vaporizer is designed for use in continuous flow techniques of inhalation anesthesia. Each vaporizer is agent specific and is clearly labeled with the anesthetic agent that it is designed for.

The vaporizer is temperature, flow and pressure compensated so that its output remains relatively constant despite cooling due to evaporation, variations in inlet flow and fluctuating pressures as described in Section 7, Effects of Variables.

The vaporizer is designed to be used on Selectatec® Series Mounted Manifolds. The vaporizer can be installed on other Selectatec Manifolds but the interlock system is designed to function on Selectatec Series Mounted Manifolds only. Mounting a Tec 7 Vaporizer on a Selectatec 7 Compatibility Block is not recommended.



ABB0008

Figure 2-1 ▪ Tec 7 Vaporizer

**⚠ WARNING** Improper use may result in patient injury.

This manual and its associated documentation must be studied before any attempt is made to install, operate or clean any part of the Tec 7 Vaporizer.

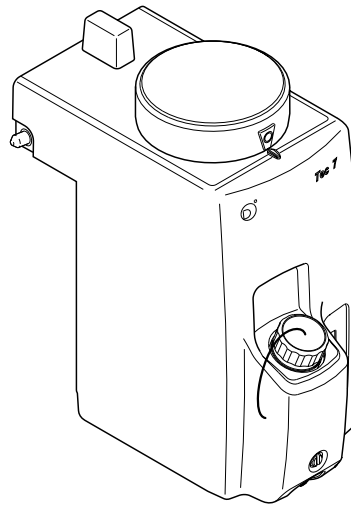
The performance of the anesthesia machine and vaporizer can be degraded if the machine and vaporizer are mis-matched.

Only operate the vaporizer with dry medical gases.

If a vaporizer containing agent in the sump has been inverted, connect it to a gas scavenging system, set the dial to 5% and purge the vaporizer with the carrier gas at 5 liters/minute for 5 minutes.

**⚠ CAUTION** The vaporizer is intended to be operated in its upright position.

Turn the vaporizer to  when it is not in use.



## Components

### Control dial

A single control dial with a concentration scale calibrated in percentage of anesthetic agent vapor per total volume (% v/v) sets the desired concentration of the anesthetic agent.

A dial release in the dial assembly helps prevent accidental displacement of the control dial from the  position. To select an ON setting, squeeze the dial release and simultaneously rotate the dial counter-clockwise.

The dial and dial release are designed to enable an ON setting to be selected using only one hand.

### Safety interlocks

The vaporizer incorporates an interlock mechanism. This mechanism also interfaces with the Selectatec® Series Mounted Manifold to help satisfy the following criteria:

- The vaporizer must be locked onto the manifold before it can be turned ON.
- Only one vaporizer at a time can be turned ON when two or more vaporizers are fitted on a Selectatec® Series Mounted Manifold.
- The gas flow enters only the vaporizer that is turned ON.
- Any unwanted anesthetic trace vapor is minimized after a vaporizer is turned to .

#### **WARNING**

Earlier versions of the Selectatec Series Mounted Manifold that provide mounting positions for three vaporizers require that if only two vaporizers are fitted, then the center position must be occupied. If the center position is not occupied, the interlock that helps ensure that only one vaporizer at a time can be turned ON is ineffective.

Later versions of the Selectatec Series Mounted Manifold that provide mounting positions for three vaporizers incorporate an additional interlock that helps ensure that only one vaporizer at a time can be turned ON even if the center position is not occupied.

### Vaporizer identification label

A vaporizer identification label is affixed to the back panel of the vaporizer as illustrated on Fig. 2-2.

An anesthesia system fitted with a vaporizer identification unit uses this label to identify the vaporizer type.

**⚠ WARNING** Do not affix any additional labels or markings to the back panel. They may adversely affect the operation of the vaporizer identification unit.

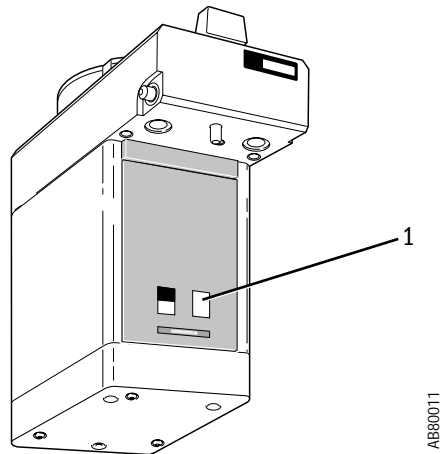

AE80011

1. Vaporizer identification label

*Figure 2-2* ▪ Vaporizer identification label

# 3 Setup and Mounting Procedure

## Vaporizer mounting procedure

The vaporizer is designed to be used on Selectatec Series Mounted Manifolds. The vaporizer can be installed on other Selectatec Manifolds but the interlock system is designed to function on Selectatec Series Mounted Manifolds only.

Mounting a Tec 7 Vaporizer on a Selectatec 7 Compatibility Block is not recommended.

**⚠ WARNING**

Do not lift or support the vaporizer by holding the control dial. Handle the vaporizer with care at all times.

Before mounting a vaporizer onto the Selectatec Series manifold, ensure that each manifold port valve O-ring is intact and that there is no foreign matter around the mating surfaces. A damaged O-ring and/or foreign matter around the mating surfaces can cause leaks.

Earlier versions of the Selectatec Series Mounted Manifold that provide mounting positions for three vaporizers require that if only two vaporizers are fitted, then the center position must be occupied. If the center position is not occupied, the interlock that helps ensure that only one vaporizer at a time can be turned ON is ineffective.

Do not use a vaporizer if the liquid level decreases below the minimum level.

Before using a vaporizer allow it to attain the ambient temperature of the location in which it has to be used.

## Mounting the vaporizer

### Step 1

Set the dial to .

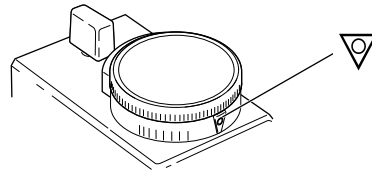

AB80001

Figure 3-1 ▪ Setting the concentration dial

### Step 2

Unlock the locking lever.

- Turn the lever counter-clockwise.
- Make sure the lever releases.

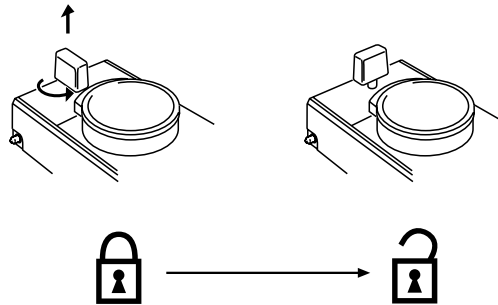

AB80002

Figure 3-2 ▪ Unlocking the locking lever

### Step 3

Prepare the manifold.

- Remove any plugs fitted to the vaporizer interlock block ports.
- Verify that each manifold port valve O-ring is intact. If necessary, remove the existing O-rings and fit one new O-ring to each port valve, as described in the relevant anesthesia system User's Reference Manual. Replacement O-rings are supplied with each vaporizer.

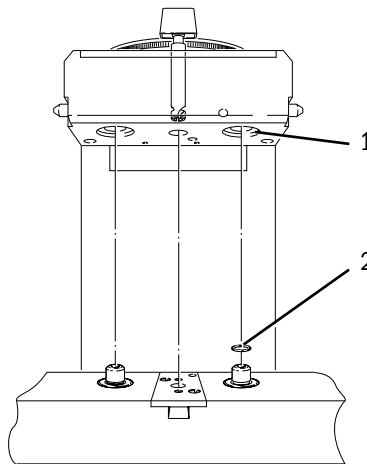

AA13052

1. Vaporizer Interlock Block Port - ensure plugs removed
2. Replace Manifold Port Valve O-ring, if necessary

Figure 3-3 ▪ Ready the manifold

**Step 4**

Install the vaporizer onto the manifold.

- Hold the main body of the vaporizer in an upright position with both hands.
- Lower the vaporizer onto the manifold, ensuring that the vaporizer interlock block ports engage correctly with the manifold port valves.

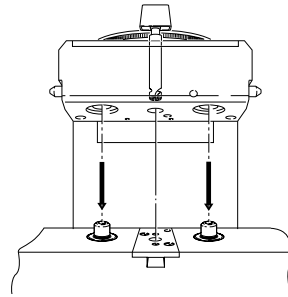

AB80018

Figure 3-4 ▪ Installing the vaporizer

**⚠ CAUTION**

Push the locking lever all the way down before turning it. The mechanism can be damaged if an attempt is made to turn the lever before it is pushed all the way down.

**Step 5**

Lock the vaporizer onto the manifold.

- Push the locking lever all the way down.
- Turn it clockwise to the locked position to lock the vaporizer onto the manifold.

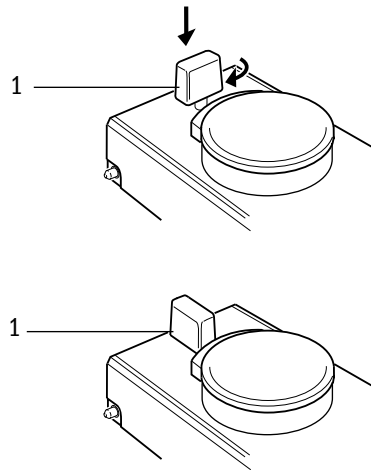

AB80004

1. Locking lever

Figure 3-5 ▪ Locking the vaporizer onto a manifold

**Step 6**

Ensure that the vaporizer is correctly mounted (see instructions on the next page).

## Checking the vaporizer for correct mounting

**⚠ WARNING** To help ensure correct operation, do not use a vaporizer that is either visibly out of line on the manifold or that can be lifted off the manifold when the locking lever is in the locked position.

If more than one vaporizer is fitted, visually check to make sure that the tops of the vaporizers are level. If the vaporizer is visibly out of line, perform steps 2 and 3 as described in *Removing the vaporizer from a manifold* and remount it correctly.

When the vaporizer appears to be level and the locking lever is in the locked position, attempt to lift the vaporizer straight up from the manifold. If the vaporizer can be lifted off the manifold, it is not correctly mounted. Remount the vaporizer (see *Vaporizer mounting procedure*).

Verify that the interlock rods are in alignment by making sure that only one vaporizer at a time can be turned ON.

Check the anesthesia system for leaks in accordance with the relevant User's Reference Manual with the vaporizer dial turned to 0% and then repeat the check with the vaporizer dial turned to .

## Removing the vaporizer from a manifold

### Step 1

Set the dial to .

If the dial is not completely turned to the  position the vaporizer cannot be released from the manifold.

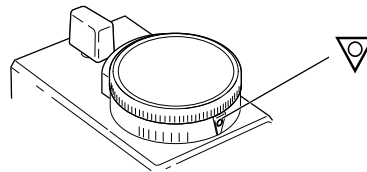

AB80001

Figure 3-6 ▪ Setting the dial

### Step 2

Unlock the locking lever.

- Turn the locking lever counter-clockwise.
- Release the locking lever and check that the locking lever springs up to the unlocked position to release the vaporizer from the manifold.

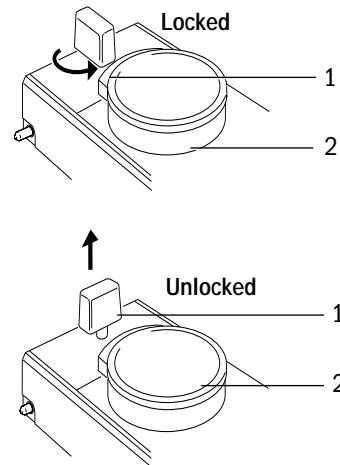

AB80003

1. Locking lever
2. Dial

Figure 3-7 ▪ Unlocking the locking lever

### Step 3

Carefully lift the vaporizer up from the manifold.

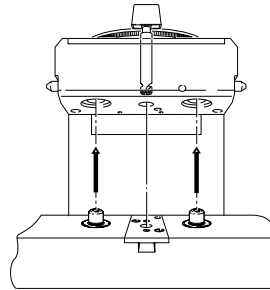

AB80019

Figure 3-8 ▪ Lifting the vaporizer





# 4 Operating Instructions

## Setting the dial

**⚠ WARNING** High percent dial settings combined with low gas flows may lead to hypoxic mixtures in the breathing circuit. Datex-Ohmeda strongly recommends the use of oxygen monitoring.

The dial release must be operated to turn the dial from the  setting.

Do not turn the dial if the vaporizer is not properly locked onto the manifold.

**Important** European Standard EN 740 - *Anesthetic Workstations and Their Modules* requires that an appropriate gas monitor is used to monitor the concentration of anesthetic agent vapor in the inspiratory gas when the vaporizer is in operation in order to provide protection against hazardous output in the event of a device malfunction.

Datex-Ohmeda strongly recommends the use of anesthesia gas monitoring with this equipment. Refer to local standards for mandatory monitoring.

## Tec 7 Vaporizer

### Step 1

Press the dial release and turn the dial in a counter-clockwise direction from the  setting.

Note that it is not possible to turn on the vaporizer if an adjacent Tec series, (except Tec 3) is turned on.

### Step 2

The vaporizer should not be used between  and the first graduation mark.

To avoid inadvertent delivery of small concentrations, turn the control dial to  when the vaporizer is not in use.

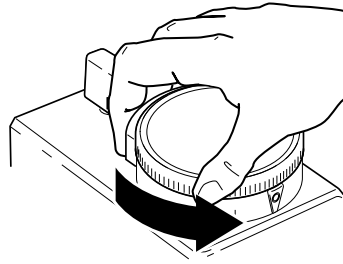

Figure 4-1 ▪ Releasing the dial

ABB0020

## Filling and draining the vaporizer

**⚠ WARNING** Do not fill the vaporizer with any agent other than the agent specified on the front label. The vaporizer is designed for that agent only. If any substance other than that specified is used, patient injury could occur.

Only fill the vaporizer when it is in an upright position. Failure to do so may result in the vaporizer being overfilled.

To avoid explosive hazards, flammable anesthetic agents such as Ether and Cyclopropane must not be used in or with this vaporizer. Only anesthetic agents that comply with the requirements for non-flammable anesthetic agents in the IEC 60601-2-13 Standard, *Particular Requirements for the Safety of Anesthesia Machines*, are suitable for use in the presence of this vaporizer.

As this vaporizer is not suitable for use with flammable anesthetic agents such as Ether or Cyclopropane, the use of antistatic breathing tubes and face masks is not necessary. The use of antistatic or electrically conductive breathing tubes when using high frequency electric surgery equipment may cause burns and is therefore not recommended in any application of this vaporizer.

Do not fill the vaporizer unless the control dial is in the  position.

Do not turn the dial ON during filling or attempt to fill beyond the  mark.

Do not drain the agent into any container other than a properly marked drug container.

Ensure that the filler cap is tightened prior to use.

When filling the Tec 7 Vaporizer, observe the following:

- Periodically check the agent level. The vaporizer should be refilled at appropriate intervals. The vaporizer is designed to function according to specification as long as there is agent visible above the  mark.
- The vaporizer must be filled and used in an upright position. Small deviations from the upright position do not affect either the output or the safety of the vaporizer.
- Every two weeks, preferably when the agent level is low, drain the contents of the vaporizer into an appropriately marked container and discard the agent. Less frequent intervals may be used when the anesthetic agent does not contain additives or stabilizing agents, but the procedure must be performed at least once every year.
- The following steps should be taken for Halothane vaporizers:
  - Drain the vaporizer every two weeks
  - If Halothane is used infrequently the vaporizer should be drained after use.
  - The decomposition of halothane causes the release of halides, which may corrode metal components particularly in the presence of moisture. Also a preservative added to halothane by its manufacturers to impede decomposition can leave a residue, which may cause vaporizer components to stick.
- If the vaporizer is not upright, check the agent level more frequently to avoid a misleading impression of the amount of agent in the vaporizer.

### Step 1

Turn the vaporizer dial clockwise to the  position.

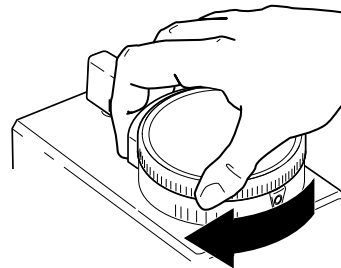

AB80021

Figure 4-2 ▪ Turning the vaporizer OFF

## Filling procedure with funnel filler

### **⚠ WARNING**

Before filling a vaporizer equipped with a funnel filler, turn the cap slowly to allow any pressure to gradually vent.

Ensure that the drain plug screw, located on the lower front of the vaporizer, is correctly tightened to help prevent loss of liquid agent.

### Step 1

Remove the filler cap by turning it counter-clockwise. Ensure that the drain plug is closed by tightening it with the tool end of the filler cap.

### Step 2

Verify that the anesthetic agent is the same as that specified on the vaporizer front label. Observe the agent level through the sight glass indicator on the side of the filler body. Pour the agent slowly into the filling port, as illustrated on Fig. 4-3, until the level reaches the ▲ mark. The level may decrease slightly as the wicks absorb the agent. To help prevent overfill, ensure the agent level is at or below the fill line.

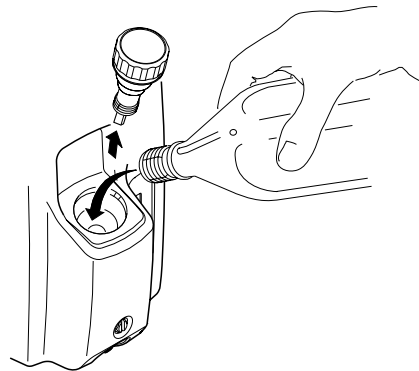

AB80022

Figure 4-3 • Filling a vaporizer that incorporates a funnel filler

### Step 3

Replace and tighten the filler cap to minimize leaks.

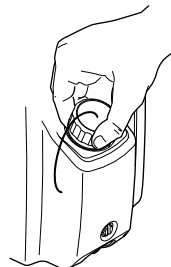

AB80013

Figure 4-4 • Replacing the filler cap

## Draining procedure with funnel filler

The vaporizer must only be drained into a properly marked container.

### **⚠ CAUTION**

Do not allow the container to become completely full during draining procedures.

### Step 1

Remove the filler cap. Insert the tool end of the cap into the drain plug below the filling port on the filler body as illustrated in Fig. 4-5.

### Step 2

Position a properly marked container under the drain spout.

### Step 3

Unscrew, but do not remove, the drain plug to allow the vaporizer contents to pour from the drain spout into the container.

### Step 4

After draining is complete, tighten the drain plug to help minimize leaks.

### Step 5

Replace and tighten the filler cap to help minimize leaks.

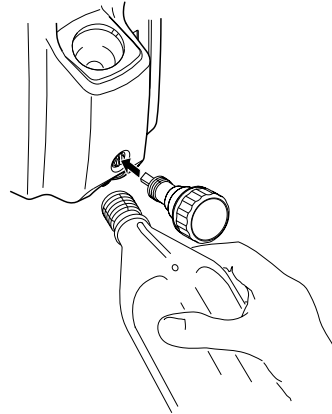

AB80023

Figure 4-5 • Draining a vaporizer with a funnel filler

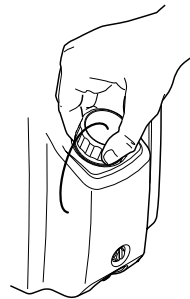

AB80013

Figure 4-6 • Replacing the filler cap

## Filling procedure with Easy-Fil™

### **⚠ WARNING**

Ensure that the drain plug screw, located on the lower front of the vaporizer, is correctly tightened to help prevent loss of liquid agent.

The filling system consists of three elements:

- the bottle collar
- the bottle adapter
- the filler block

The vaporizer must only be filled using the correct agent specific filling system.

### Step 1

Align the notches on the bottle adapter to the bottle collar and tighten the adapter onto the agent bottle.

### Step 2

Remove the filler cap. Align the bottle adapter keys with the index slots in the filler block as illustrated in Fig. 4-7. Insert the bottle nozzle into the filler block.

### Step 3

Press the agent bottle fully into the vaporizer filler block. Allow the liquid to flow into the vaporizer until the maximum level mark ▲ is reached. To help prevent overflow, ensure the agent level is at or below the fill line. Pay particular attention to the level in the sight glass and the air return bubbles flowing into the bottle.

### Step 4

Release the bottle when the vaporizer is full and the continuous stream of bubbles ceases.

### Step 5

Remove the bottle from the vaporizer filler. Replace the filler cap and the cap on the agent bottle. Ensure that the filler cap is tightened to help minimize leaks.

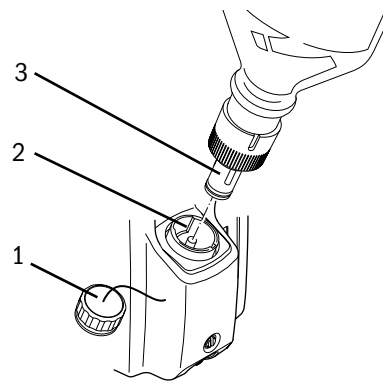

1. Filler cap
2. Index slot
3. Bottle adapter

Figure 4-7 ▪ Filling a vaporizer with Easy-Fil

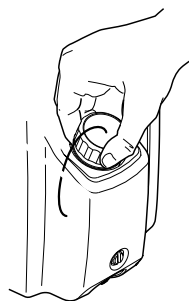

Figure 4-8 ▪ Replacing the filler cap

## Draining procedure with Easy-Fil

**⚠ CAUTION**

Do not allow the container to become completely full during draining procedures.

The vaporizer must only be drained into a properly marked container.

### Step 1

Remove the cap from the vaporizer filler.

### Step 2

Place the empty container opening under the drain nozzle as shown in Fig. 4-9.

### Step 3

Unscrew the drain plug with the tool attached to the filler cap. Drain the vaporizer until empty.

### Step 4

After draining, tighten the drain plug to help minimize leaks.

### Step 5

Replace and tighten the filler cap to minimize leaks.

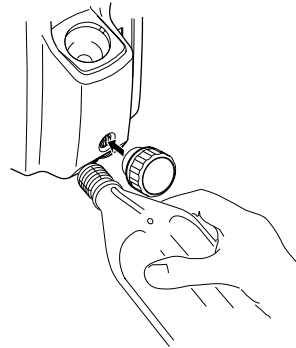

AB80014

Figure 4-9 • Unscrewing the drain plug

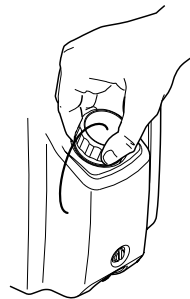

AB80013

Figure 4-10 • Replacing the filler cap



## Filling procedure with Quik-Fil™

### **⚠ WARNING**

Ensure that the drain plug screw, located on the lower front of the vaporizer, is correctly tightened to help prevent loss of liquid agent.

### Step 1

Remove the protective cap from the anesthetic agent bottle filler, checking that the bottle and filler mechanism are not damaged.

### Step 2

Remove the filler cap. Insert the bottle nozzle into the filler block. Rotate the bottle to align the bottle filler nozzle keys with the index slots in the filler block as illustrated on Fig. 4-11.

### Step 3

Press the agent bottle fully into the vaporizer filler block. Allow the liquid to flow into the vaporizer until the maximum level mark ▲ is reached. Pay particular attention to the level in the sight glass and the air return bubbles flowing into the bottle.

### Step 4

Release the bottle when the vaporizer is full and the continuous stream of bubbles ceases. To help prevent overflow, ensure the agent level is at or below the fill line.

### Step 5

Remove the bottle from the vaporizer filler. Replace the filler cap and the cap on the agent bottle. Ensure that the filler cap is tightened to help minimize leaks.

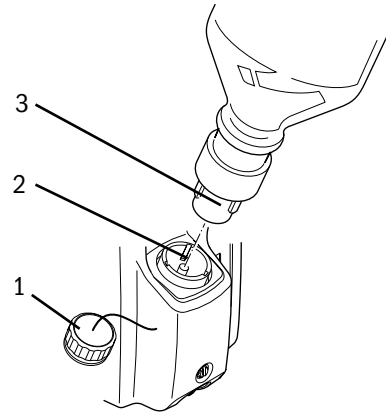

AB80015

1. Filler cap
2. Index slot
3. Nozzle key

Figure 4-11 ▪ Filling a vaporizer with a Quik-Fil

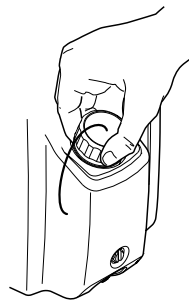

AB80013

Figure 4-12 ▪ Replacing the filler cap

## Draining procedure with Quik-Fil

**⚠ CAUTION**

Do not allow the container to become completely full during draining procedures.

The vaporizer must only be drained into a properly marked container.

### Step 1

Remove the cap from the vaporizer filler.

### Step 2

Place the empty container under the drain nozzle as shown in Fig. 4-13. Screw bottle onto drain spout.

### Step 3

Unscrew the drain plug with the tool attached to the filler cap. Drain the vaporizer until empty.

### Step 4

After draining, tighten the drain plug to help minimize leaks.

### Step 5

Replace and tighten the filler cap to minimize leaks.

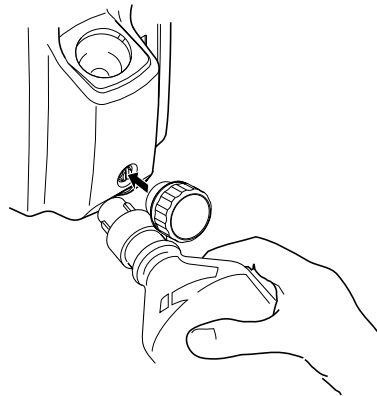

AB80026

Figure 4-13 ▪ Unscrewing the drain plug

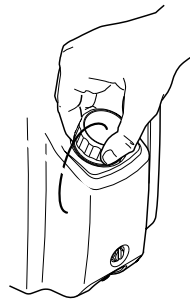

AB80013

Figure 4-14 ▪ Replacing the filler cap

# 5 Maintenance

## User maintenance

**⚠ WARNING** Do not modify, tamper with, or disassemble the vaporizer. Doing so can damage the unit and alter the graduation accuracy.

## Maintenance intervals

Prior to performing any maintenance procedures or returning to a service center for repairs, clean and disinfect the vaporizer.

**Every two weeks:** When the agent is low, drain the contents of the vaporizer into an appropriately marked container and discard the agent. For Halothane vaporizers check the output of anesthetic agent periodically with an agent monitor. See note below.

<b>Three years from purchase date and every six months thereafter:</b>	Planned safety inspections together with the anesthesia system by qualified personnel.
	Inspect and perform output concentration check.

**Note** The decomposition of Halothane causes the release of halides, which may corrode metal components particularly in the presence of moisture. Also a preservative added to Halothane by its manufacturers to impede decomposition can leave a residue, which may cause vaporizer components to stick. If Halothane is used infrequently the vaporizer should be drained after use.

## Cleaning

### **⚠ WARNING**

Do not put water or any other solvent into a vaporizer. A vaporizer should be filled with the specified anesthetic agent only.

Do not immerse the vaporizer in water or any other liquid.

Do not autoclave the vaporizer.

### **External cleaning**

To clean external surfaces, use a moist cloth and neutral detergent (pH 7 to 10.5).

Never allow cleaning agents to accumulate either in the filler, the gas inlet and outlet ports or around the control dial.

### **Internal contamination**

If the vaporizer is filled or partly filled with an incorrect volatile agent or other contaminant (such as water), proceed as follows:

1. Remove the vaporizer from service immediately and label the vaporizer stating that it is contaminated. Discard all liquid.
2. Return the vaporizer to a Datex-Ohmeda Authorized Service Center stating that the vaporizer is contaminated and, if possible, the type of contaminant in the vaporizer.

### **Output concentration check**

Connect the Tec 7 to an Anesthesia Machine.

1. Set the oxygen output of the anesthesia machine to a flow of  $5 \pm 0.5$  L/min.
2. Ensure that the fresh gas output is connected to a gas scavenging system.
3. Measure the concentration at the fresh gas outlet, using an agent monitor which is calibrated to measure the specific agent.
4. Allow the readings to stabilize and check that the readings are within specified tolerances.
5. Document and maintain the test results, including the date, person performing the test, and serial number of the unit tested.

**The accuracy of the measuring equipment must be considered when obtaining the readings!**

<b>Sevoflurane Dial Setting</b>	<b>Min Vol%</b>	<b>Max Vol%</b>
1%	.6	1.40
3%	2.55	3.45
5%	4.25	5.75
<b>Enflurane, Halothane or Isoflurane Dial Setting</b>	<b>Min Vol%</b>	<b>Max Vol%</b>
1%	.75	1.25
3%	2.55	3.45
5%	4.25	5.75

## Checking the calibration

The performance of most vaporizers that are in clinical use can be confirmed by observing patient signs and consumption of anesthetic agents. Some users may, however, wish to employ analyzers either as a routine procedure or as part of an investigation to determine whether any abnormalities of performance have developed.

To help to achieve the reliability and consistency of performance of the Tec 7 Vaporizer, Datex-Ohmeda uses closely specified test conditions, test methods and detailed protocol in conjunction with training, experience and quality auditing systems. For these reasons, the full program necessary to help to ensure that a vaporizer complies with Datex-Ohmeda specifications cannot practicably be carried out in a field situation.

The following points must be considered when any measurements are being carried out on vaporizers to assist in determining whether any abnormalities of performance have developed.

1. To predict the concentration that the vaporizer can be expected to deliver, the detailed nominal performance data and the preceding comments must be taken into account.
2. The method of test used must not be such that it bears little relation to normal conditions of clinical use.
3. Any sampling techniques used must be such as to ensure the following:
  - a. The sample is fully representative of the vaporizer output, which may not be a homogeneous mixture at the vaporizer outlet.
  - b. The absorption of agent by any connecting tubing is negligible.
4. If a number of vaporizers are being examined at the same time the probability of all of them being consistently in error is so remote as to be negligible and the cause of any apparent error probably lies in the test method employed.
5. Consistent and reproducible analytical techniques must be used.
6. If unexpected results are obtained, it is a wise precaution to repeat the observation because the vaporizer may be more reliable than the techniques used to observe its performance.

7. If unexpected results occur, it is also worthwhile checking for sources of error such as the flowmeter, leaks or absorption by adjacent components.
8. Full account must be taken of any extraneous effects on the analyzer that may arise from changes in the carrier gas composition.
9. If the anesthetic machine on which the vaporizer is fitted is left for a period of time with no gases flowing, sensitive analyzers may detect small concentrations of agent for a short time at the machine outlet after the gas flow is turned ON with the vaporizer turned to  $\nabla$ . This is a normal machine characteristic caused by residual vapor left in the machine from previous use.
10. When the vaporizer is turned from  $\nabla$  to 0% or above after a period out of use, an increased concentration may occur that rapidly stabilizes to the set concentration within approximately 10 seconds at 5 liters/minute flow.
11. At the 0% setting it is normal for small steady concentrations to be observable on sensitive analyzers.

## Analytical techniques

For field checking of the state of calibration, many techniques and analyzers are available. Datex-Ohmeda would not recommend any one technique or analyzer in preference to another, but the calibration and reliability of analyzers must be realistically considered and account must be taken of errors of use.

The following method of checking can be used where special equipment is not available or where a secondary check of analyzers is desired. The characteristics of the vaporizer are such that, if the vaporizer is satisfactory at one dial setting, it should be satisfactory at all other graduations.

1. Ensure that the vaporizer is at least half full and has been at an ambient temperature of  $21 \pm 2^\circ \text{C}$  for at least three hours.
2. With the vaporizer securely mounted, drain the vaporizer as detailed in Section 4 and, after draining, ensure that either the drain plug and the filler cap are both securely tightened or the port valve is fully closed and the locking clamp is in the up position, as appropriate.
3. Check that the control dial is turned to  $\nabla$  and then carefully and quickly pour a measured 50 milliliters of agent into the vaporizer without spilling.
4. Leave the vaporizer at a nominal temperature of  $21 \pm 2^\circ \text{C}$  for one hour to help to ensure that the temperature has stabilized.
5. Set the flowrate to 5 liters/minute oxygen.
6. Turn the control dial to 2%, note the time and check that the flowrate is still 5 liters/minute. Readjust the flowrate as necessary.
7. Leave the vaporizer at this setting for 30 minutes. Periodically check and adjust the flowrate as necessary. Turn the vaporizer to  $\nabla$  and turn the oxygen OFF.

8. Drain the vaporizer as detailed previously in Instruction 2 and measure the amount of liquid drained off. The amount of liquid consumed should be as follows:

Enfluratec	15.5 milliliters
Fluotec	13.5 milliliters
Isotec	15.5 milliliters
Sevotec	16.6 milliliters

Appropriate action must be taken to handle the exhaust gases and spillage.

**Note** This method is designed to be a quick and easy check of vaporizer operation and, therefore, it is somewhat imprecise. However, it is unusual for the measured liquid consumption to vary by more than 25% of the values listed above.

## Service Policy

Repairs and service procedures must be performed at a Datex-Ohmeda Authorized Service Center. Contact your Datex-Ohmeda Service Representative or Datex-Ohmeda Authorized Distributor for information on maintenance and shipping.







# 6 Principle of Operation

## Interlock mechanism

The vaporizer locking lever is interlocked with the vaporizer percentage control dial so that the control dial release, located at the rear of the dial, cannot be actuated until the vaporizer locking lever is in the locked position.

With the vaporizer locking lever in the locked position, the dial release can be pressed in toward the dial to operate the interlock mechanism, which allows the manifold port valves to open, prevents an adjacent vaporizer from being turned on, and allows the vaporizer to operate.

Turning the control dial to  automatically reverses the operating sequence, which allows the dial release to move out to lock the dial in the  position, closes the manifold port valves and vents the vaporizer gas connecting ports, and allows an adjacent vaporizer to be turned ON.

Turning the locking lever to the unlocked position releases the vaporizer allowing it to be removed from the manifold.

## Delivery of gas/ agent vapor

### Overview

The output concentration of the Tec 7 Vaporizer is regulated by the 'variable flow-split' method described in the following text and shown in figures 6-1 and 6-2.

A total flow of fresh gas from upstream flowmeters enters the vaporizer from the flowmeter where it is immediately split into two streams. One stream flows into the fresh gas bypass circuit and the other stream flows through the vaporizing chamber where it is enriched with the vapor of the liquid anesthetic agent.

## Bypass circuit

The bypass circuit includes the gas transfer manifold and also a thermostat assembly that is located at the base of the vaporizer.

The fresh gas flows through the bypass circuit vertically downwards across the sump base through the thermostat and back up the gas transfer manifold to the common gas outlet as shown in Figure 6-1.

The thermostat deflects according to its temperature to control the resistance offered to the flow of gas through it. This deflection varies the relative proportions of gas flowing through the bypass and vaporizing chamber circuits.



ABB0.039

1. Gas from flowmeter
2. Sump base
3. Thermostat
4. Gas transfer manifold
5. To common gas outlet
6. Shut-off open
7. Vaporizing chamber
8. Flow control (vapor channel)
9. Rotary valve

Figure 6-1 ▪ Bypass circuit

## Vaporizing chamber circuit

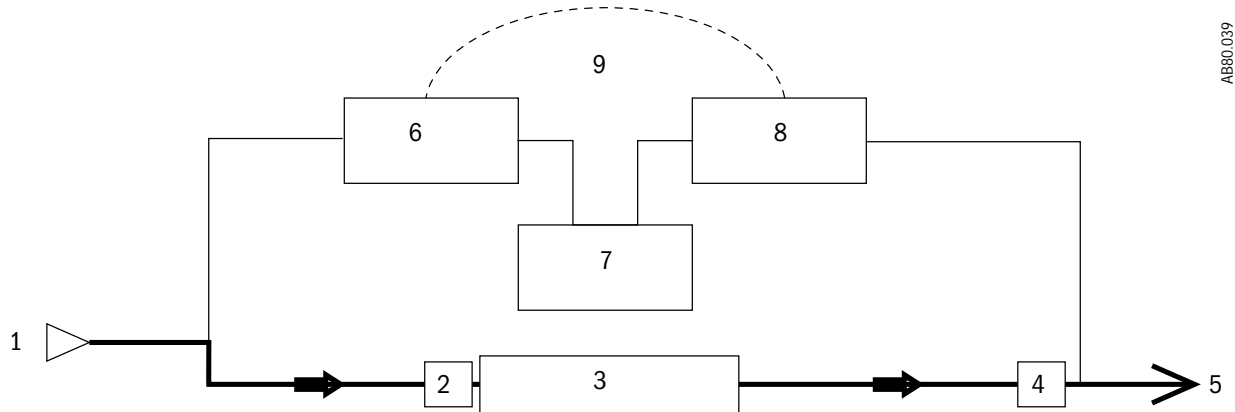
The fresh gas flow through the vaporizing chamber, as shown on Figure 6-2, flows from the flowmeter across the sump cover where it is diverted through the central cavity of the rotary valve and back through the Intermittent Positive Pressure Ventilation (IPPV) compensating assembly.

Gas now flows from the IPPV assembly down through the tubular wick assembly where it picks up anesthetic vapor and then flows across the base of the vaporizing chamber above the liquid agent.

From the base of the vaporizing chamber the gas/agent mixture flows through the sump cover to the proportional radial drug control groove of the rotary valve and then back into the sump cover where it combines with the fresh gas from the bypass circuit.

The combined total flow then flows out from the vaporizer and via the Selectatec circuitry to the anesthesia gas delivery system.

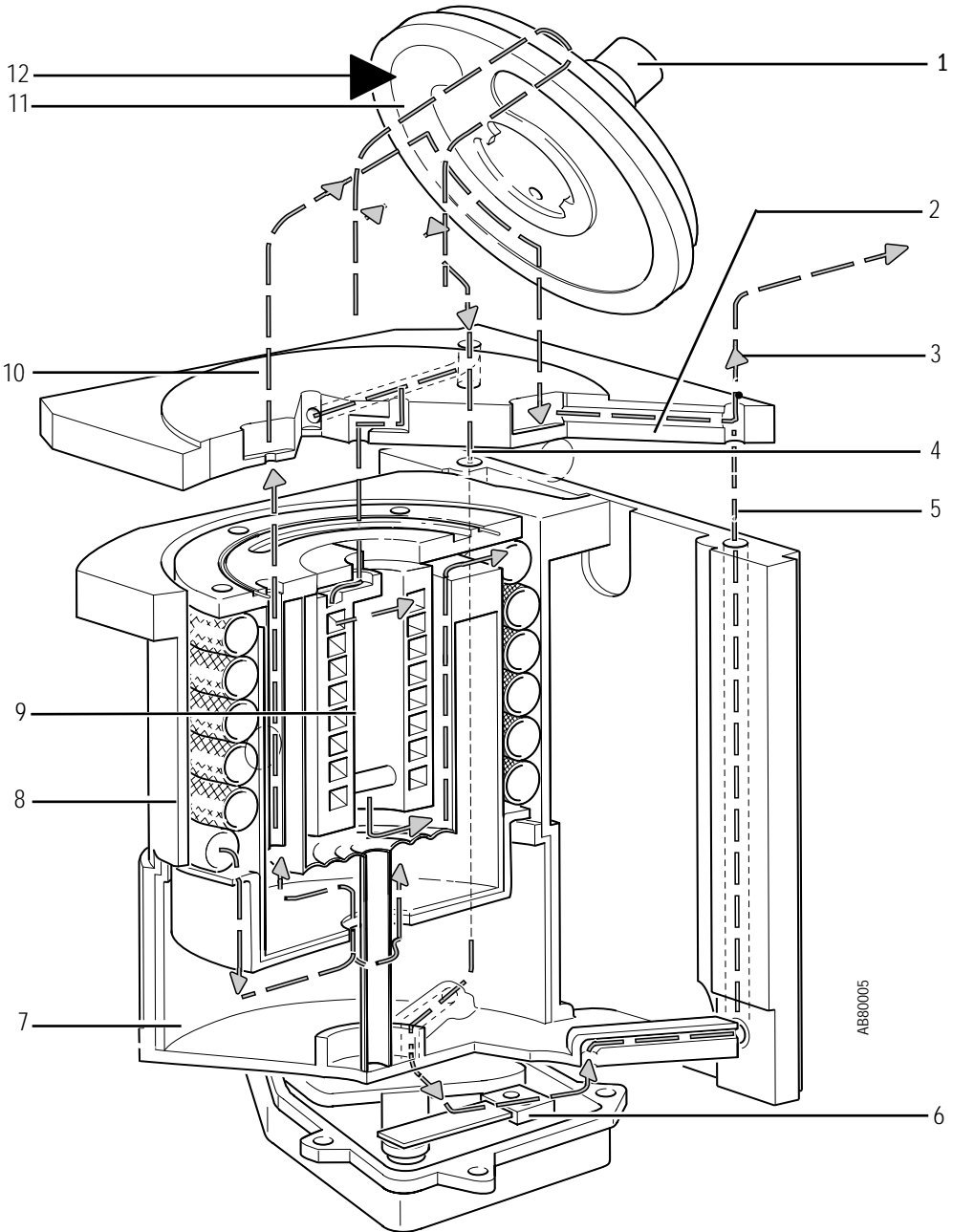

- 1. Rotary valve
- 2. Enriched fresh gas out
- 3. Combined fresh gas and enriched gas out
- 4. Fresh gas bypass
- 5. Fresh gas out
- 6. Thermostat
- 7. Vaporizing chamber
- 8. Wick assembly
- 9. IPPV compensating assembly
- 10. Sump cover
- 11. Vapor control channel
- 12. Shown in ON position

Figure 6-2 • Vaporizer schematic



# 7 Specifications

**Note** All specifications are nominal and subject to change without notice.

## Calibration

Check the calibration certificate that is included with your Tec 7 Vaporizer.

Vaporizers are calibrated at 21 °C using an oxygen carrier gas at a flow of 5 liters/minute and they are temperature, flow and pressure compensated within the specified operating range.

 **WARNING** The Tec 7 Vaporizer can only be calibrated at a Datex-Ohmeda Authorized Service Center.

## Performance

Accuracy at 5 liters/ min O <sub>2</sub> 21 ± 2 °C	Vaporizer 5%: ± 0.25% of delivered agent or ± 15% dial setting (whichever is greater) Vaporizer 8%: ± 0.4% of delivered agent or ± 15% dial setting (whichever is greater)
Liquid capacity	To fully charge a vaporizer with dry wicks: 300 ml (nominal) Retained by wick system: 75 ml (nominal) To fill from minimum to maximum mark: 5% Vaporizer: 170 ml (nominal) 8% Vaporizer (Sevotec): 137 ml (nominal)
Flow resistance at 5 liters/minute of O <sub>2</sub> at 21 ± 2 °C	10 - 15 cm H <sub>2</sub> O with Vaporizer setting ON +0%
Operating temperature range	18 °C to 35 °C (64 °F to 95 °F)
Storage temperature range	-40 °C to 65 °C (-40 °F to 149 °F) <b>Note:</b> Protect the vaporizer packaging from condensation.

## Weight and dimensions

Weight	7 kg	15 lb 6 oz (empty)
Depth	210 mm	8.25 inches
Width	110 mm	4.375 inches
Height	250 mm	9.875 inches (in the unlocked position)

# Flow characteristics

## Isotec 5%

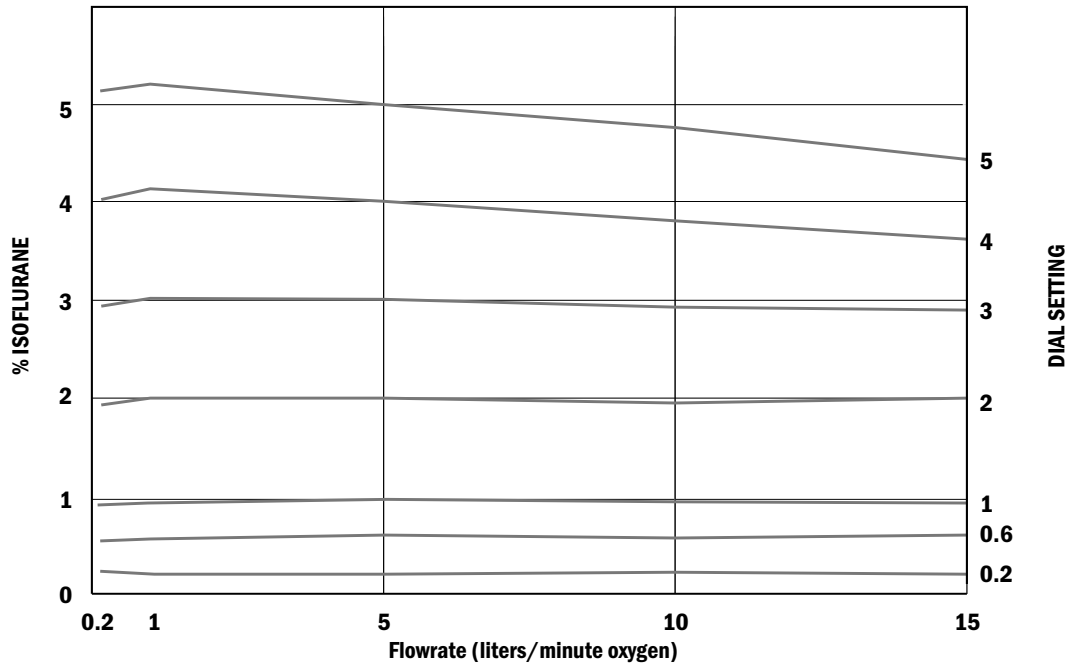

Figure 7-1 ▪ Effect of Flowrate at  $21 \pm 2^\circ \text{C}$  with oxygen flowing

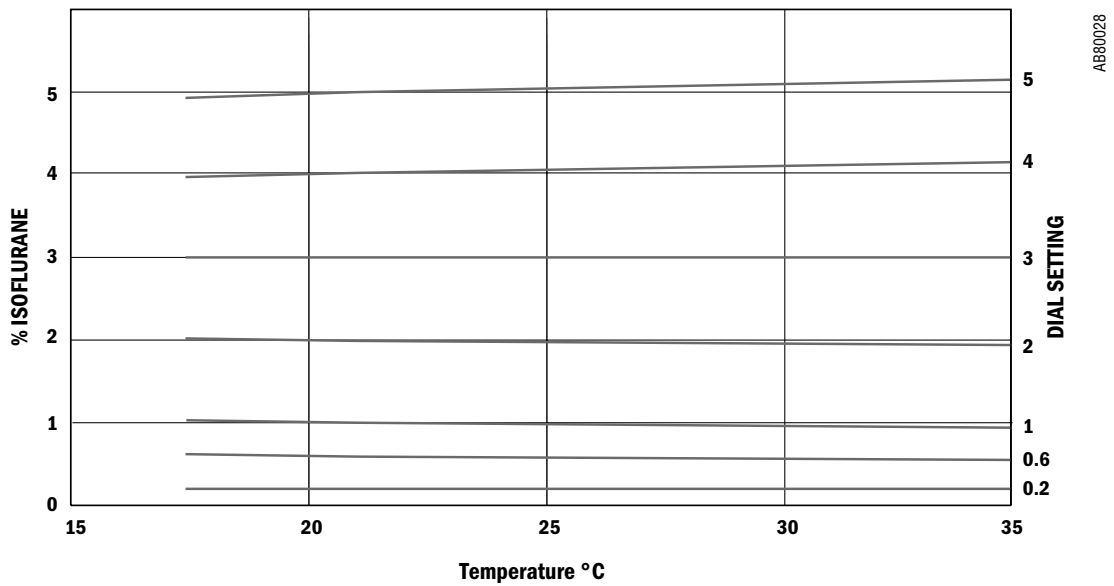

Figure 7-2 ▪ Effect of temperature at 5 liters/minute with oxygen flow

### Fluotec 5%

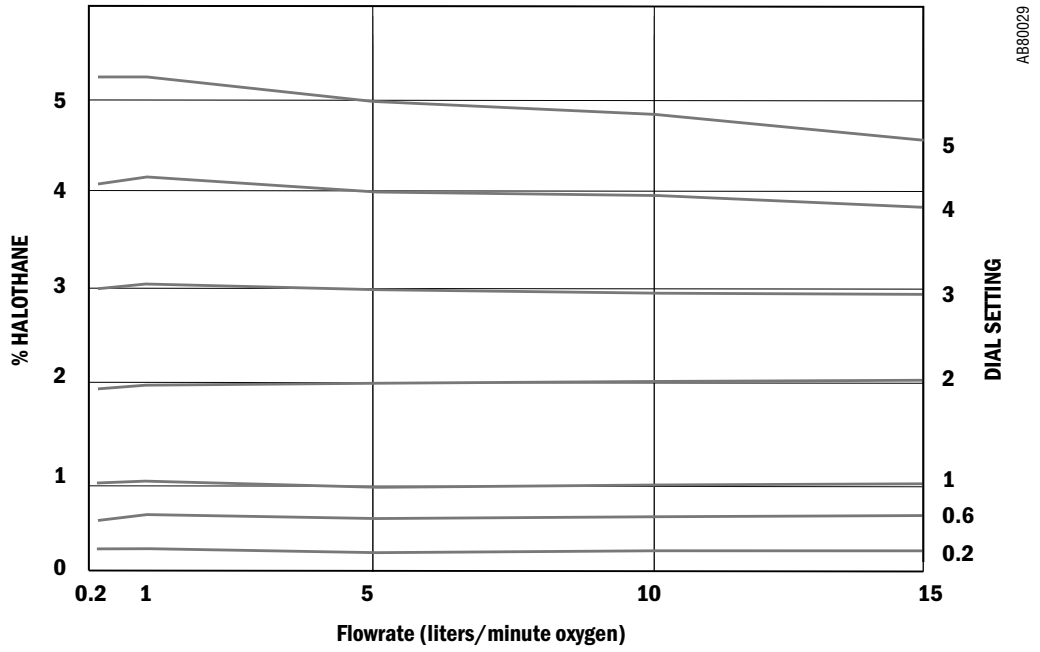

Figure 7-3 ▪ Effect of Flowrate at  $21 \pm 2^\circ \text{C}$  with oxygen flowing

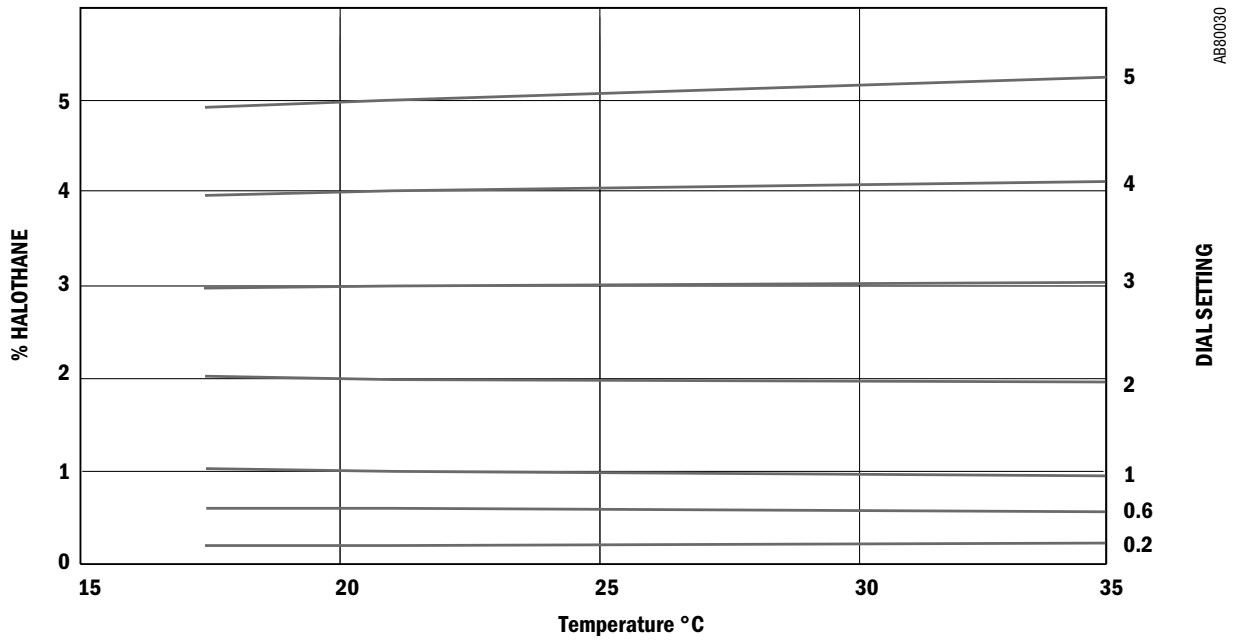

Figure 7-4 ▪ Effect of temperature at 5 liters/minute with oxygen flow



**Sevotec 5%**

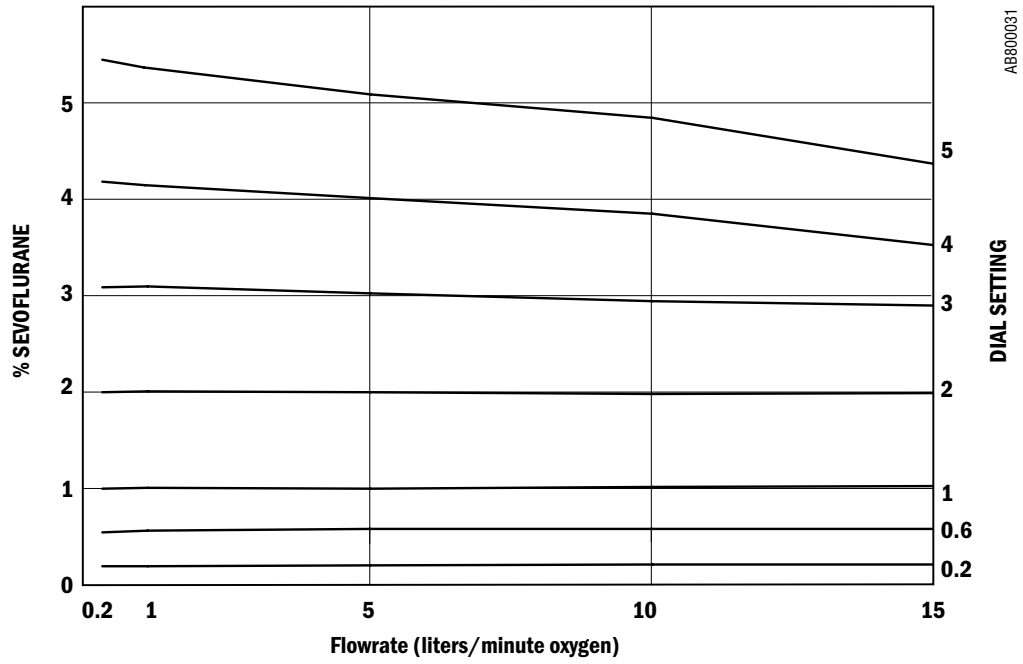

Figure 7-5 ▪ Effect of Flowrate at 21 ± 2° C with oxygen flowing

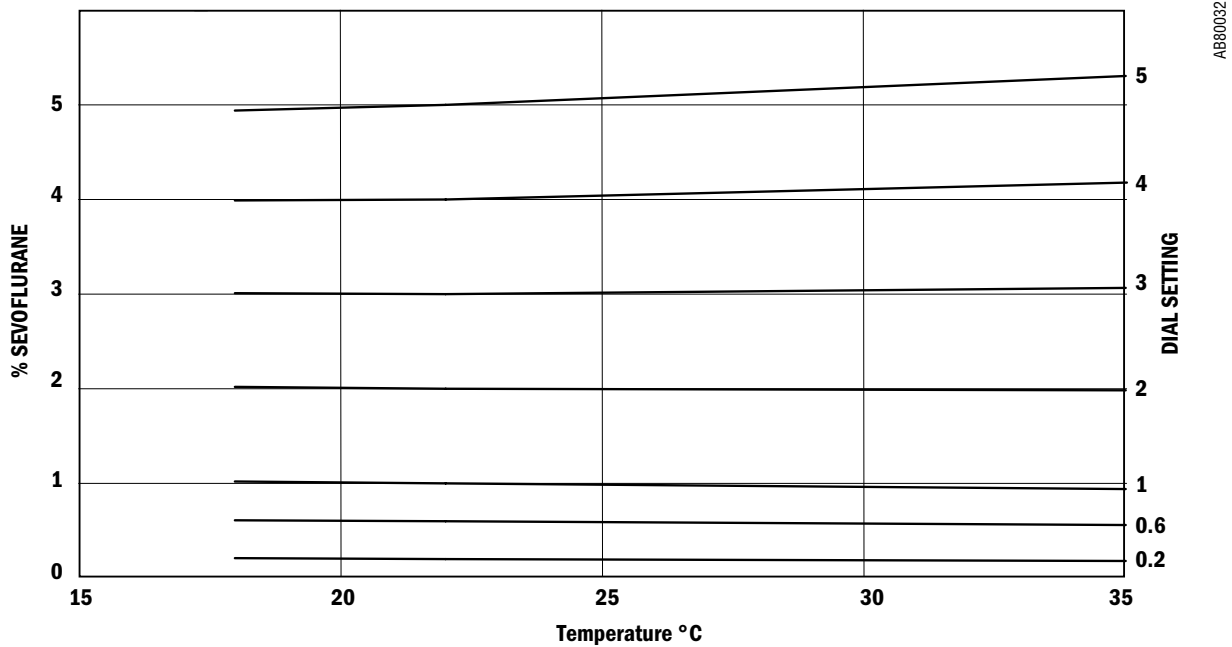
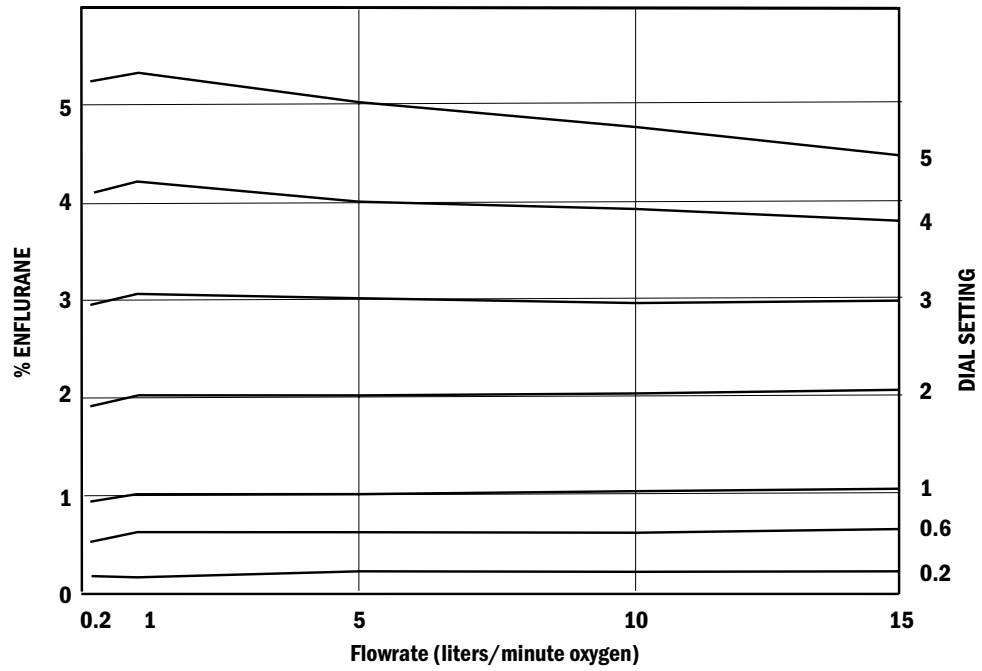

Figure 7-6 ▪ Effect of temperature at 5 liters/minute with oxygen flow

### Enfluratec 5%



AB80035

Figure 7-7 ▪ Effect of Flowrate at  $21 \pm 2^\circ \text{C}$  with oxygen flowing

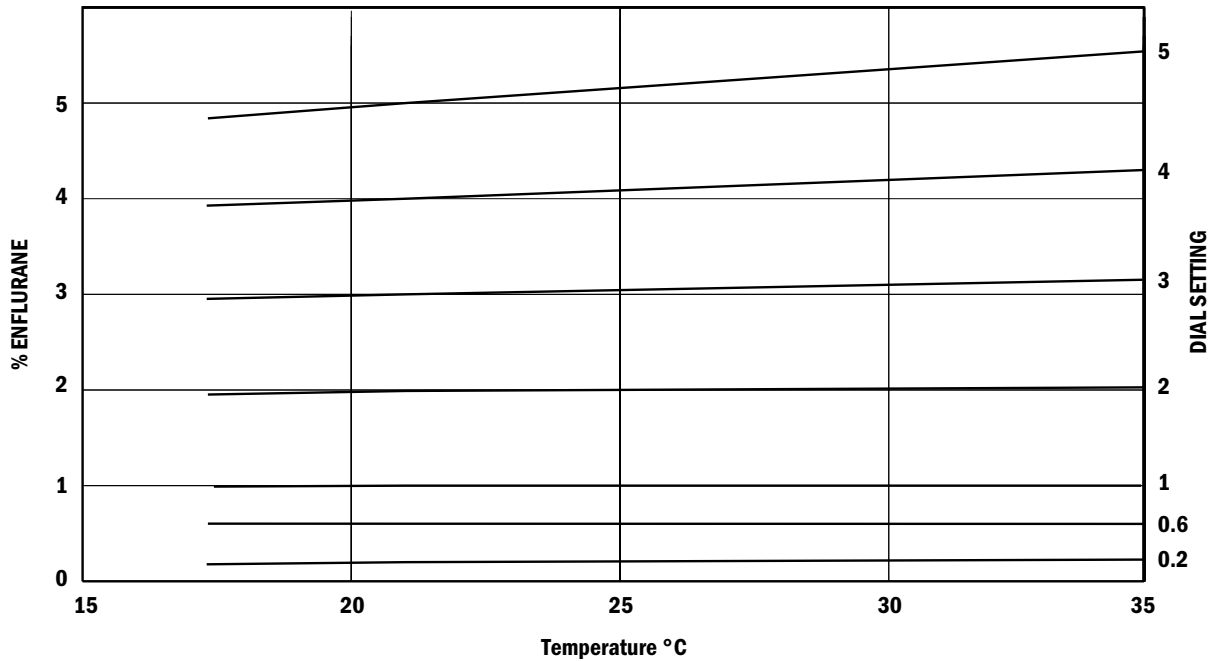

AB80036

Figure 7-8 ▪ Effect of temperature at 5 liters/minute with oxygen flow

**Sevotec 8%**

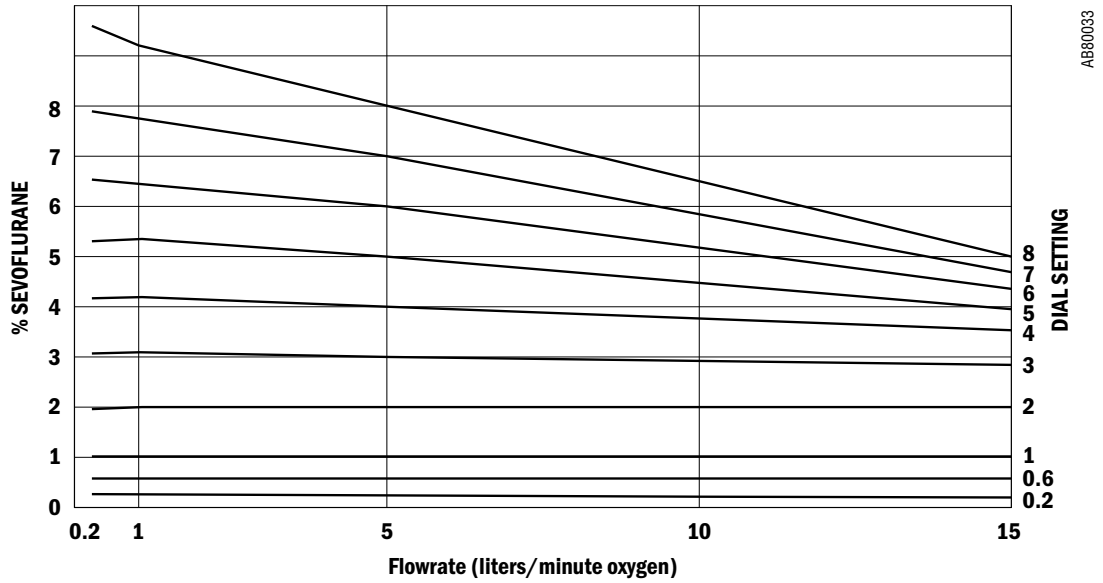

Figure 7-9 ▪ Effect of Flowrate at  $21 \pm 2^\circ \text{C}$  with oxygen flowing

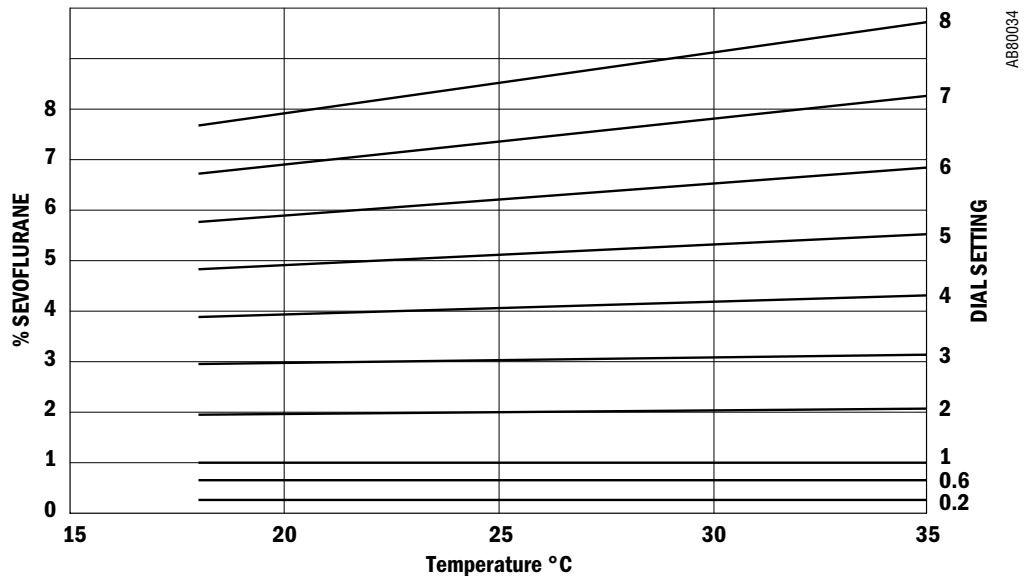

Figure 7-10 ▪ Effect of temperature at 5 liters/minute with oxygen flow

## Effects of variables

### Anesthetic agent consumption

#### Isoflurane, Halothane and Enflurane

The rate of consumption of anesthetic agent depends primarily on flowrate and vapor output concentration. As an approximate working figure, 1 milliliter of liquid anesthetic is required to provide 200 milliliters of vapor.

The approximate hourly consumption of anesthetic agents can be expressed as  $3 \times \% \times F$ , where % represents the setting of the vaporizer output percentage and F represents the input flowrate in liters/minute.

Example: If a vaporizer is set to deliver 2% at 6 liters/minute total gas input flowrate then the approximate rate of consumption =  $3 \times 2 \times 6 = 36$  ml/hour.

The figures are approximate and are intended for general guidance only.

#### Sevoflurane

The rate of consumption of anesthetic agent depends primarily on flowrate and vapor output concentration. As an approximate working figure, 1 milliliter of liquid anesthetic is required to provide 200 milliliters of vapor.

The approximate hourly consumption of anesthetic agents can be expressed as  $3.3 \times \% \times F$ , where % represents the setting of the vaporizer output percentage and F represents the input flowrate in liters/minute.

Example: If a vaporizer is set to deliver 2% at 6 liters/minute total gas input flowrate then the approximate rate of consumption =  $3.3 \times 2 \times 6 = 39.6$  ml/hour.

The figures are approximate and are intended for general guidance only.

### Barometric pressure

The Tec 7 Vaporizer is calibrated in percent v/v at 760 mmHg. If the ambient pressure changes the % v/v changes, so that at an ambient pressure P mmHg the delivered percentage (D% v/v) is calculated as follows:

$$D = \frac{\% \times 760}{P} \quad \text{where \% is the nominal setting of the vaporizer.}$$

To obtain a consistent depth of anesthesia when gross changes of barometric pressure occur, the % v/v must be changed in inverse proportion to the barometric pressure.

The vaporizer automatically makes this % v/v change and for practical clinical purposes the effects of barometric pressure can be ignored.

## Ambient temperature

The effects of variation in temperature are normally negligible at commonly used combinations of dial setting and ambient temperature.

If the vaporizer temperature is above the range shown on the performance curves, the vaporizer output may be unpredictably high, particularly if the temperature of the agent approaches the agent boiling point specified by the agent manufacturer.

If the vaporizer temperature is below the range shown on the performance curves, the vaporizer output may be lower than expected.

To help avoid inaccuracies due to extreme temperatures, before using the vaporizer it must be allowed to attain a temperature within the range shown on the performance curves.

## Back pressure

### WARNING

Pressures in excess of 400 mmHg may overcome the internal pressure balance and cause a variation in output.

## Steady back pressure

The vaporizer cannot distinguish between pressures at the outlet due to barometric pressure and pressures in excess of barometric due to steady back pressures applied by downstream components. The equation given in the section Barometric Pressure therefore applies with the term P now being the absolute pressure at the outlet, that is, barometric pressure plus back pressure. Steady back pressure reduces the % v/v.

Currently, it is unlikely that the steady back pressure imposed by commonly used downstream components, other than some ventilators, exceeds 30 mmHg at commonly used flowrates. Back pressures as high as 30 mmHg would reduce the delivered % v/v, at 760 mmHg barometric pressure, to the following:

$$\frac{760}{790} = 0.96 \text{ of what would otherwise be expected.}$$

Under normal clinical circumstances effects of this magnitude can be ignored.

## Fluctuating back pressure

Fluctuating back pressure may be imposed on the vaporizer by downstream components and/or assisted or controlled ventilation to the patient. These fluctuating back pressures can affect the vaporizer and increase the concentration by intermittently altering the pressures, and consequently the flow distribution, within the vaporizer.

The greatest effects are observed at combinations of very low flowrates and low dial setting with large and rapid pressure fluctuations. The effects become progressively less important as the dial setting and flowrate increase and the magnitude and rate of cycling of the pressure fluctuations decrease.

## Carrier gas composition

Small output decreases can occur when the carrier gas composition is changed from 100% oxygen.

When either air or nitrous oxide is employed as the carrier gas, the output is lowered compared to the output when oxygen is the carrier gas. This effect is the greatest (up to 20% of setting) at low flows when nitrous oxide is employed, but using nitrous oxide reduces the required inspired concentrations of volatile agent that can, depending upon the proportion, mitigate the decreases in output from the vaporizer.

### **WARNING**

Only operate the vaporizer with dry medical gases.

## Time out of service

If the anesthesia machine on which the vaporizer is fitted is left for a period of time with no gases flowing, small concentrations may be detected at the machine outlet immediately after the gas flow is turned ON. This is a normal machine characteristic and is caused by residual vapor left in the machine from previous use.

When the vaporizer is turned from the  setting after a period out of use, a brief high concentration may occur that rapidly stabilizes to the set concentration within approximately 10 seconds at 5 liters/minute.

These phenomena are normal characteristics of vaporizers. In use the volume of vapor involved is small compared to the volume of the breathing circuit.

## Effects of variables

Ambient temperature, input flowrate and duration of use can affect delivered concentration, particularly when the vaporizers are used at extremes of the usual clinical range.

### **Note**

Use of the vaporizer at high gas flows and high dial concentrations may affect the accuracy of delivered concentrations. Refer to Performance Curves in this chapter for full information.

The valve design and temperature compensation system of Tec 7 Vaporizers reduces the effects to levels such that, under most clinical conditions, their effect on vaporizer performance is not clinically significant.

## Warranty

This Product is sold by Datex-Ohmeda under the warranties set forth in the following paragraphs. Such warranties are extended only with respect to the purchase of this Product directly from Datex-Ohmeda or Datex-Ohmeda's Authorized Dealers as new merchandise and are extended to the Buyer thereof, other than for the purpose of resale.

For a period of 36 months from the date of original delivery to Buyer or to Buyer's order, but in no event for a period of more than three years from the date of original delivery by Datex-Ohmeda to a Datex-Ohmeda Authorized Dealer, this Product, other than its expendable parts, is warranted against functional defects in materials and workmanship and to conform to the description of the Product contained in this User's Reference Manual and accompanying labels and/or inserts, provided that the same is properly operated under the conditions of normal use, that regular periodic maintenance is performed and that replacements and repairs are made in accordance with the instructions provided. This same warranty is made for a period of thirty (30) days with respect to expendable parts. The foregoing warranties shall not apply if the Product has been repaired other than by Datex-Ohmeda or in accordance with written instructions provided by Datex-Ohmeda, or altered by anyone other than Datex-Ohmeda, or if the Product has been subject to abuse, misuse, negligence, or accident.

Datex-Ohmeda's sole and exclusive obligation and Buyer's sole and exclusive remedy under the above warranties is limited to repairing or replacing, free of charge, at Datex-Ohmeda's option, a Product, which is telephonically reported to the nearest Datex-Ohmeda Customer Support Center and which, if so advised by Datex-Ohmeda, is thereafter returned with a statement of the observed deficiency, not later than seven (7) days after the expiration date of the applicable warranty, during normal business hours, transportation charges prepaid, and which, upon Datex-Ohmeda's examination, is found not to conform with above warranties. *Datex-Ohmeda shall not be otherwise liable for any damages including but not limited to incidental damages, consequential damages, or special damages.*

*There are no express or implied warranties which extend beyond the warranties hereinabove set forth. Datex-Ohmeda makes no warranty of merchantability or fitness for a particular purpose with respect to the product or parts thereof.*

# Datex-Ohmeda

## Corporate Office



Datex-Ohmeda Division  
Instrumentarium Corp.  
PO Box 900  
FIN-00031 Helsinki  
Finland  
Tel 358 10 394 11  
Fax 358 9 146 3310

## North America

### United States

#### **Customer Service, Technical Support and Distribution Center**

Datex-Ohmeda, Inc.  
PO Box 7550  
Madison, WI 53707-7550, USA  
Tel 1 800 345 2700  
Fax 1 608 221 4384

#### **Equipment Service Center**

Datex-Ohmeda, Inc.  
1315 West Century Drive  
Louisville CO 80027-9560, USA  
Tel 1 800 345 2700  
Fax 1 303 373 1607

### Canada

Datex-Ohmeda (Canada) Inc.  
1093 Meyerside Drive, Unit 2  
Mississauga, Ontario  
L5T 1J6  
Canada  
Tel 1 800 268 1472  
Tel 1 905 565 8572  
Fax 1 905 565 8592

## Asia/Pacific

### China

Datex-Ohmeda Pte. Ltd.  
Room B416, COFCO Plaza  
8 Jianguomennei Avenue  
Beijing 100005, PR China  
Tel 86 10 6526 9773  
Fax 86 10 6526 0653

Datex-Ohmeda Pte. Ltd.  
Room 1708, Yunlong Mansion  
No. 122 Luoguo Street  
Chengdu 610017, PR China  
Tel 86 28 661 4424  
Fax 86 28 676 2703

Datex-Ohmeda Pte. Ltd.  
403 Huan Shi Dong Road  
Room 1602, GIE Tower  
Guangzhou, 510095, P R China  
Tel 86 20 8732 2521  
Fax 86 20 8732 2518

Datex-Ohmeda Pte. Ltd.  
Room 2509 Lippo Plaza  
No. 222 Huaihai Road (M)  
Shanghai 200021, P.R. China  
Tel 8621 5382 5657  
Fax 8621 5382 1691

Datex-Ohmeda Pte. Ltd.  
Room 809, Truroll Plaza  
Wusheng Road  
Wuhan 430033, P R China  
Tel 86 27 8571 2536  
Fax 86 27 8571 2655

### India

Datex-Ohmeda (India) Pvt. Ltd.  
Block EP & GP, Sector V  
Plot XI-16, Salt Lake City  
Calcutta 700091  
India  
Tel 91 33 3574002  
Fax 91 33 3574001

### Indonesia

Datex-Ohmeda Pte. Ltd.  
Wisma Danamon Aetna Life 19th Floor  
Jln. Jend Sudirman Kav. 45-46 Jakarta  
12930, Indonesia  
Tel 62 21 575 0864  
Fax 62 21 575 0865

### Japan

Datex-Ohmeda K. K.  
TRC Annex 9F  
6-1-1 Heiwajima  
Ohta-ku, Tokyo 143-0006  
Japan  
Tel 81 3 5763 6801  
Fax 81 3 5763 6838

Datex-Ohmeda K. K.  
Technical Center  
TRC A Bldg. AE 4-8  
6-1-1 Heiwajima  
Ohta-ku, Tokyo 143-0006  
Japan  
Tel 81 3 5763 6850  
Fax 81 3 5763 6852

### Korea

Datex-Ohmeda Pte. Ltd.  
10th Floor, Sam Sung Building  
36 - 1, Yoido-Dong, Youngdeungpo-Ku  
Seoul, Korea  
Tel 82 2 786 7421  
Fax 82 2 786 7420

### Malaysia

Datex-Ohmeda Pte. Ltd.  
Level 2 Bangunan O' Connor  
13 Jalan 223  
46100 Petaling Jaya  
Selangor, West Malaysia  
Tel 60 3 754 7872  
Fax 60 3 757 6948

### Singapore

Datex-Ohmeda Pte. Ltd.  
152 Beach Road  
#12-05/07 Gateway East  
Singapore 189721  
Tel 65 391 8618  
Fax 65 291 6618

### Thailand

Datex-Ohmeda Pte. Ltd.  
12th Floor (Unit F) Grand Amarin Tower  
1550 New Petchburi Road, Makasan, Rajathevi,  
Bangkok 10320, Thailand  
Tel 66 2 2071012/13  
Fax 66 2 207 1014

### Taiwan and Philippines

Datex-Ohmeda Pte. Ltd.  
2nd Floor, No. 85, Chien-Kuo North Road,  
Sec. 2  
Taipei, Taiwan  
Republic of China  
Tel 886-2 2515-0457  
Fax 886-2 2501-9136

### Vietnam

Datex-Ohmeda Pte. Ltd.  
522G Nguyen Tri Phuong St.  
Ho Chi Minh City, Dist. 10 Vietnam  
Tel 848 865 5875  
Fax 848 862 5501

### Australia

Datex-Ohmeda Pty. Ltd.  
Units 1 & 2  
149 Arthur Street  
P O Box 356  
Homebush  
NSW 2140  
Australia  
Tel 61 132 229  
Fax 61 297 461796

### Europe

**CIS/Baltics**  
Datex-Ohmeda  
Regional Head Office  
PO Box 70071  
GR-16610 Glyfada - Athens  
Greece  
Tel +30 10 9625136-7  
Fax +30 10 9623687

### France

Datex-Ohmeda S.A.S.  
ZAC de Sans-Souci  
1211 Chemin de la Bruyère  
F-69760 Limonest  
France  
Tel 33 (0) 4 78 66 62 10  
Fax 33 (0) 4 78 43 26 58

### Germany

Datex-Ohmeda GmbH  
Dr. Alfred-Herrhausen-Allee 24  
D-47228 Duisburg  
Germany  
Tel 49 2065 691-0  
Fax 49 2065 691-236

### Italy

Datex-Ohmeda S.p.A.  
Via Cassanese 100  
20090 Segrate, Milan  
Italy  
Tel 39 2 21693431  
Fax 39 2 26926226

### Netherlands

Datex-Ohmeda B.V.  
Kantemarsweg 18  
Post Box 22  
3870 CA Hoevelaken  
Netherlands  
Tel 31 33 253 5404  
Fax 31 33 253 7223

### Spain

Datex-Ohmeda S.L.  
C/Manuel Tovar 26  
28034 Madrid  
Spain  
Tel 34 1 334 26 00  
Fax 34 1 358 12 84

### United Kingdom

Datex-Ohmeda Ltd.  
Ohmeda House  
71 Great North Road  
Hatfield Hertfordshire  
AL9 5EN England  
Tel 44 1707 263570  
Fax 44 1707 260191

### Latin America, Caribbean

Datex-Ohmeda  
9155 South Dadeland Blvd.  
Suite 1218  
Miami, FL 33156, USA  
Tel 1 305 670 8540  
Fax 1 305 670 2316

### Middle East

Datex-Ohmeda  
Regional Head Office  
PO Box 70071  
GR-16610 Glyfada - Athens  
Greece  
Tel +30 10 9625136-7  
Fax +30 10 9623687

The addresses listed on this cover are current as of 4/02. For any location changes, please visit our website at [www.datex-ohmeda.com](http://www.datex-ohmeda.com) and click on the Contacts button.

Datex-Ohmeda, Inc.  
PO Box 7550  
Madison WI 53707-7550  
USA  
Tel 608 221 1551  
Fax 608 222 9147  
[www.datex-ohmeda.com](http://www.datex-ohmeda.com)

Tec 7 vaporizer  
User's Reference Manual, English  
1175 0013 000  
06 02 A 18 05 02  
Printed in USA  
©Datex-Ohmeda, Inc. All rights reserved